













Quantura Q10+ Laundry Dosing System

Safety Notes

IMPORTANT:

Please read the following precautions carefully before using this equipment.

-  This unit contains high voltage circuits that may expose you to the danger of electric shock.
-  Means for disconnection must be incorporated in accordance with the wiring rules.
-  **Do not** open the enclosure without isolating the signal and supply sources. Ensure that these sources have been isolated for at least 5 minutes before entering the enclosure.
-  **Do not** power the unit outside of the values stated on the rating label.
-  **Do not** use damaged or frayed cables.
-  **Do not** dismantle or modify this equipment.
-  **Never** insert fingers into mechanisms without turning the power supply off first.
-  **Do not** mount the unit to unstable, irregular or non-vertical surfaces.
-  **Do not** place heavy objects on top of the unit.
-  **Do not** attempt to place items (such as screwdrivers) into the moving parts of the pump head.
-  **Always** ensure that care is taken when handling chemicals.
-  **Do not** discard of the manual, this must be retained.

This unit must be installed by suitably qualified personnel in accordance with local regulations, or in the absence of local regulations, installed in accordance with the applicable requirements in the National Electrical Code, NFPA 70, Canadian Electrical Code (CEC), Part 1, CSA C22.1, and Standard for Ventilation Control and Fire Protection of Commercial Cooking Operations, NFPA 96.

This appliance can be used by children age from 8 years and above and persons with reduced physical, sensory or mental capabilities or lack of experience and knowledge if they have been given supervision or instruction concerning use of the appliance in a safe way and understand the hazards involved. Children shall not play with the appliance. Cleaning and user maintenance shall not be made by children without supervision.

If the supply cord is damaged, it must be replaced by the manufacturer, its service agent or similarly qualified persons in order to avoid hazard.

Before Installation

Ensure you have checked all parts required are present and inspect for any damage before installation. In the unlikely event your items are faulty, **DO NOT** install faulty or damaged parts as this unsafe and will void any warranty. Please return to your distributor in the original delivery condition including any packaging. This unit is **ONLY** to be installed by a suitably qualified person complying with local regulations.

Quantura Q10+

Peristaltic tubing x 1 (Silicone 5mm)

Ceramic weight and foot filter x 1

Remote dose controller x1

PVC Tubing 1 x 3m (10ft)

Fixings Pack: Screws x 2 Wall plugs x2



Installation

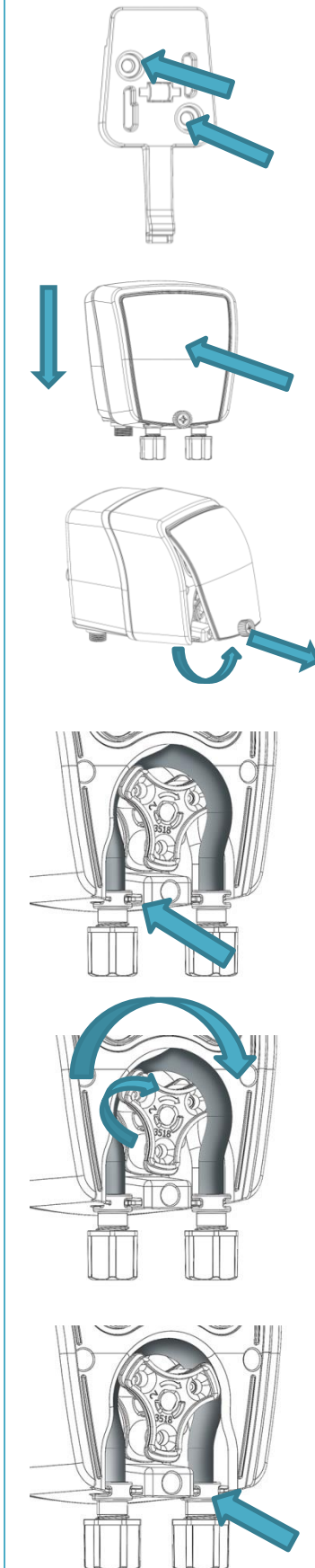

Mounting and connection

Step 1: Using the wall plugs and screws specified for this unit, fix the mounting bracket to the wall. There is an embedded spirit level to aid with this part of the installation.

Step 2: Mount the unit to the wall by hooking it onto the wall bracket. As you push the unit down you should hear a click sound.

Step 3: Ensure there is no power to the unit. Remove front cover by turning thumb screw anti-clockwise and pulling the front cover towards you as shown.

Step 4: Insert one end of the tube ensuring that it is slotted into the body of the enclosure as shown.

INFORMATION: Silicone grease provided must be applied to the tube and the pump & rotor assembly before the tube is inserted. Failure to apply the grease will affect the pump performance during operation.

Step 5: Now by manually rotating the pump head, feed the tube into the unit as shown.

IMPORTANT to aid prolonging tube life and efficient running, please use the **Silicone Grease** (supplied) on the outer of the tube. Spread liberally to the outside of the tube to help ease installation, this will also aid continuous smooth operation and help prevent any potential snagging.

Step 6: Now insert the other end of the tube ensuring that it is slotted into the body of the enclosure as shown.

IMPORTANT INFORMATION: Brightwell Dispensers Ltd (manufacturer) accepts no responsibility and/or damages caused to either the product or premises if the installation process is not complied with in full.

Connecting Chemicals

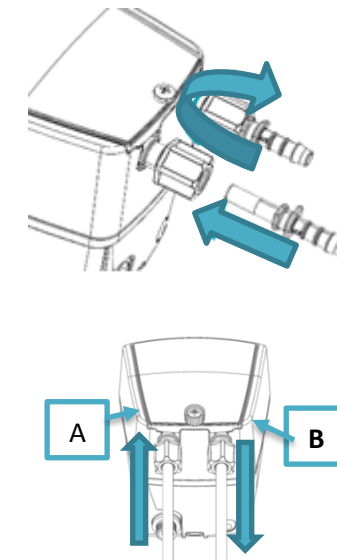

Step 1: Ensure there is no power to the unit, push the tube adapters into the clamp nuts. Then tighten the clamp nuts.

Step 2: Connect the suction tube from the chemical container to (A). Now connect the delivery tube from (B) to the injection point.

Power Supply

Should the supply cord be damaged, it should be replaced by the manufacturer or its service agent or a similarly qualified person in order to avoid a hazard.

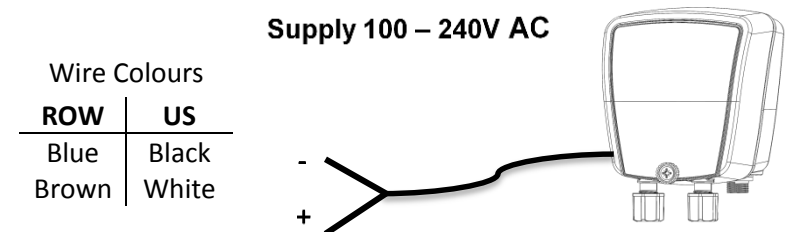

Connecting or Replacing Handset

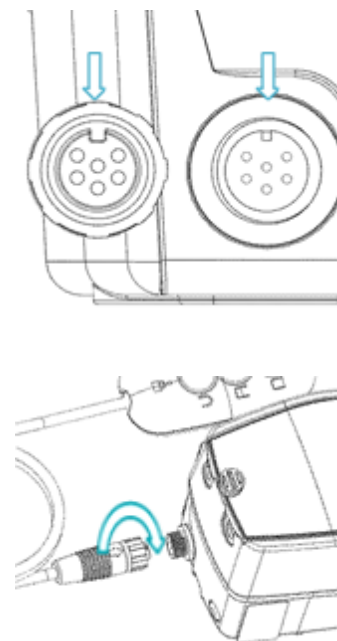

Step 1: Offer up the connector handset to the connector of the unit (positioned underneath the pump). Make sure the connector is lined up correctly as it will only fit in a certain position.

Step 2: Tighten the connector by turning it clockwise until finger tight.
Note: Do not overtighten

Initial Set up - Programming

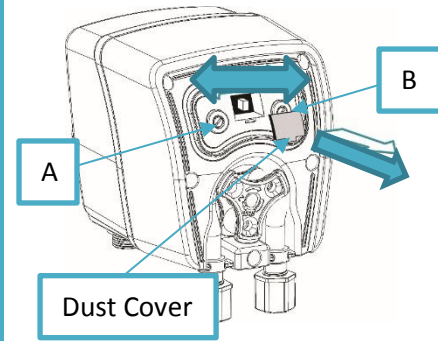

Selecting between Learn Mode and Run mode

Remove the dust cover with a screw driver. Use the screwdriver to flick the switch **Left** for Learn Mode and **Right** for Run mode (normal operating mode).
IMPORTANT – The switch must be in the **Left** position on the first power up.

Learn mode (Switch in left position)

Power up the unit. All the LEDs will briefly light up and then the Blue LED will flash indicating that the unit is in LEARN MODE.

Step 1: Potentiometer **A** – Adjust A to set the initial delay time between 0 & 20 minutes. All the way to the left = 0 Minute.

The initial delay is the period of time the pump will pause after the activation button has been pressed to allow for the machine to fill.

Step 2: Potentiometer **B** – Used to adjust the Lockout period after Pump has run (2-60 Minutes).

Lock out time is a period of time the pump will not be usable, after it has dosed chemical to prevent multiple dosing.

Pump Speed

Press and hold the Prime (bottom) button to adjust the pump speed. The pump speed will reduce in 10% increments down to 50% speed and when you release the button the speed will be set.

*If this section is skipped the pump will run at 100% speed.

Half Dose

Press and release (for 0.5 seconds) the Half load (Middle) button. The pump will start running and the Yellow LED will flash. Each flash indicates 1 second of run time. When the desired run time is achieved, press and release (for +/- 0.5 seconds) the Full load button again. *if this section is skipped it will be set as a 0 run time.

Flowrate – 140ml/min (4.7 fl.oz/min)

NOTE: Flowrates measured with water, Suction length of 2 metres

Full Dose

Press and release (for 0.5 seconds) the Full load (Top) button. The pump will start running and the Green LED will flash. Each flash indicates 1 second of run time. When the desired run time is achieved, press and release (for +/- 0.5 seconds) the Full load button again. Maximum run time is 3 minutes.

Please note.

Should you make an error in any of these settings, just repeat the procedure of the individual setting.

RUN MODE.

Move the switch to the right hand side to enter Run mode. The unit will now be ready to use.

Operating Instructions

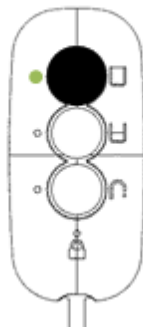
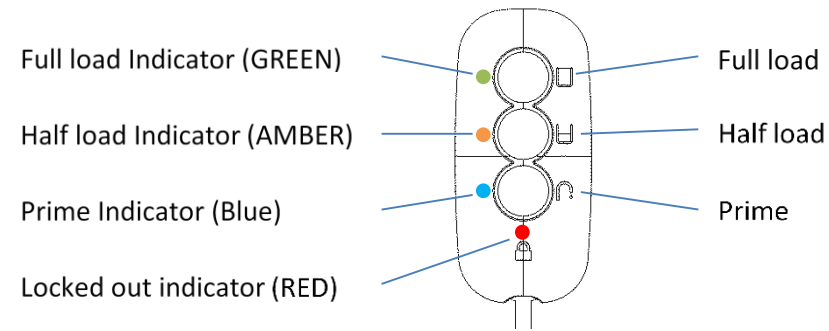

Selecting a full dose of chemical

Pressing the top button indicated with a  symbol will activate the full dose of chemical. When pressed the LED next to this button will turn solid Green to demonstrate the command has been accepted. If a delay has been set the LED will flash, showing it has been activated, but in the delay period. Once the dose is complete the RED LED shown below will switch on to demonstrate the unit is currently locked out until the Lock out time has elapsed.

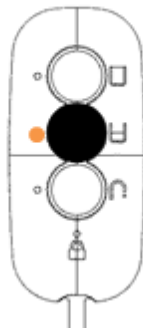

Selecting a half dose of chemical

Pressing the middle button indicated with a  symbol will activate a half dose of chemical. When pressed the LED next to the button will turn solid Amber to demonstrate the command has been accepted. If a delay has been set the LED will flash, showing it has been activated, but in the delay period. Once the dose is complete the RED LED shown below will switch on to demonstrate the unit is currently locked out until the Lock out time has elapsed.

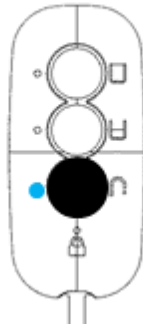

Priming the pump

To prime the system, press and hold the bottom button  for 2 seconds. The LED will turn solid Blue and the pump will run for the duration the button is held for. Once the button is released the pump will exit prime mode.



The pump has a maximum run time of 3 minutes per event. The pump cannot be programmed to run longer than this per event.

Service Intervals

1. Pump Tube Servicing: It is recommended the pump tubes are inspected for performance once every 3 months and lubricated with silicone grease to prolong tube life.
2. Pump Calibration: As a guide once every 3 months it is recommended the flow produced is checked to ensure consistent flow over the life of the tube. To do this run the pump for minute and capture the flow produced. Compare this figure with the run time of the pump to ensure the correct dosage is produced.
3. Pump Tube replacement: As a guide it is recommended the tube is replaced for a new piece once every 6 months, or as needed.

Optional Feature – Disable Prime mode

It is possible to disable the prime mode feature to prevent unwanted miss use of the system. *(feature only available in run mode)*

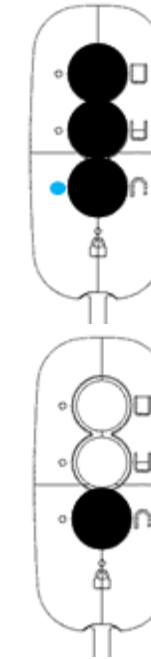

Step 1: Hold down all three buttons at the same time until the Prime indicator lights solid Blue (5 seconds)

Step 2: When the Blue indicator is on press the Prime button until the RED lock out indicator turns ON.

Prime mode is now disabled

To reinstate Prime mode

Step 1: Hold down all three buttons at the same time until the Prime indicator turns solid Blue.

Step 2: Press and hold the Prime button until the Green LED turns solid green.

Prime mode is now reinstated

WEEE Directive

Please remember to respect the local regulations: hand in the non-working electrical equipment's to an appropriate waste disposal centre. The packaging material is recyclable. Dispose of the packaging in an environmentally friendly manner and make it available for the recyclable material collection-service.